

Computer-Controlled K-Band Frequency Synthesizer Using Self-Injection Locked Phase-Locked Optoelectronic Oscillator: Part 1

Afshin S. Daryoush, Tianchi Sun and Nicholas Bromhead
Drexel University, Philadelphia, Pa.
Ajay K. Poddar and Ulrich L. Rohde
Synergy Microwave Corp., Paterson, N.J.

A two-part article is presented describing a highly stable computer-controlled K-Band frequency synthesizer using a tunable optoelectronics oscillator (OEO). The first part describes LabVIEW control of a rack-mountable frequency synthesizer covering 16 to 24 GHz. A narrowband computer-controlled filter is realized using a broadband YIG filter combined with a narrowband, optically-tuned transversal filter. A forced self-injection locked phase-locked loop (SILPLL) technique is employed to suppress side-modes generated in OEOs because of long fiber delay lines, which reduces the oscillator phase noise to an estimated 12 fs timing jitter. Computer control of this SILPLL OEO is demonstrated with linear chirp (FMCW) and pseudo-random frequency hopping. Future generations of the forced SILPLL OEO will use integrated optoelectronics. In Part 2 of the article, compact OEO solutions based on designs compatible with Si photonics are described.

High frequency oscillators are important for high speed data transmission. Forced oscillation is a technique where the oscillation frequency can be stabilized using the concept of injection locking (IL)¹⁻² and phase-locked loops (PLL).³⁻⁵ Distribution of a highly stable, low phase noise external frequency

reference is employed to force the oscillator to lock to the clean phase noise characteristics of the reference. The indirect optical injection locking⁶⁻⁷ has been applied to distributed microwave⁸ and mmWave oscillators⁹⁻¹⁴ for optical control of large phased-array antennas for radar and communications.¹⁵⁻¹⁸ The analytical modeling of

Technical Feature

injection locked oscillators has been developed based on parametric oscillation¹⁹⁻²⁴ to achieve low phase noise from various frequency references. The combination of both injection locking with a phase-locked loop is proposed as an injection locked, phase-locked loop (ILPLL) forced stabilization process, and its superior performance is experimentally demonstrated. A number of oscillator topologies²⁵⁻²⁸ are used for efficient front-end operation of a low phase noise, high frequency stability²⁸ low free-running phase noise oscillator, combined with mixing conversion gain with high dynamic range. Prime power and space saving are also achieved.²⁶⁻²⁷ It is feasible to combine mixing with oscillation and phase shifting¹⁷ as a very elegant solution for electronically scanned phased-array antennas for communication and remote sensing.

The category of oscillators based on long optical delay lines to provide high frequency stability²⁹ is known as OEO.³⁰ This structure has been widely employed for implementing high frequency RF oscillators because of its high spectral purity,³¹ and it has been extended to operate to 50 GHz.³² One of the challenges encountered with the OEO is the temperature sensitivity of the long fiber-optic delay lines.³³ Performance can be improved by employing passive temperature compensation using special

hollow-core photonic crystal fibers (HC-PhC),³⁴ improving both short-term and long-term frequency stability.³⁵ The broadband behavior of fiber-optic delay lines provides frequency tuning of the OEO with a large number of potential oscillation frequencies. Narrowband filters are the core part of an OEO, determining the oscillation frequency by employing extremely narrowband fixed frequency filters.³³ To achieve broadband frequency tuning, YIG filter structures³⁶ are integrated in the optical delay line,³⁷ as reported with FET-based tunable oscillators.³⁸ Even though the OEO can have a higher quality factor with longer fiber delay lines, multiple side-modes exist around the oscillation frequency; 5 km of fiber will have side-mode oscillations every 40 kHz. Removing them is not feasible, even using narrowband electronic filters. Coarse tuning of a wideband YIG filter³⁶ combined with fine tuning a narrowband wavelength-tuned optical transversal filter³⁹⁻⁴³ using short delay lines or a chirped fiber Bragg grating⁴⁴ provides high resolution frequency selectivity. Nonetheless, a number of side-modes persist, although forced oscillation techniques can reduce the oscillation side-modes.⁴⁴

The benefits of ILPLL²⁵ in electronic systems⁴⁵ are from improvements in close-in phase noise, pull-in time and the locking and tracking ranges, compared to the standard

IL or PLL, and reduced prime power and space compared to a multiplier chain. These benefits can also be achieved in oscillators without an external frequency reference, using the concepts of self-IL (SIL)⁴⁶⁻⁴⁹ or self-PLL (SPLL).⁵⁰⁻⁵² They improve phase noise both close-in and far from the carrier, while oscillation side-modes are suppressed using multiple loops with harmonic delays. SIL and SPLL can be combined as SILPLL,⁵³ demonstrating improvement in close-in phase noise of dielectric resonator oscillators⁵⁴ and significant side-mode suppression, yielding low timing jitter.⁵⁵

This article focuses on the development of a self-forced OEO and is presented in two parts. Part 1 discusses the design and testing of a 19 in. rack-mountable, computer-controlled K-Band synthesizer with high frequency resolution. The SILPLL OEO design uses a Mach-Zehnder modulator (MZM) and YIG filter combined with an optical transversal filter to achieve extremely narrowband frequency operation. The synthesizer employs a dual-drive modulator (DD-MZM)⁵⁶ with a bias voltage dependence of either the quadrature point ($V_{\pi}/2$) or pinch-off voltage (V_{π}). The operating point close to $V_{\pi}/2$ has higher gain, while operation at V_{π} results in lower gain with second-order harmonic generation. Low phase noise is achieved over 16 to 24 GHz, with a frequency resolution of 20 kHz/

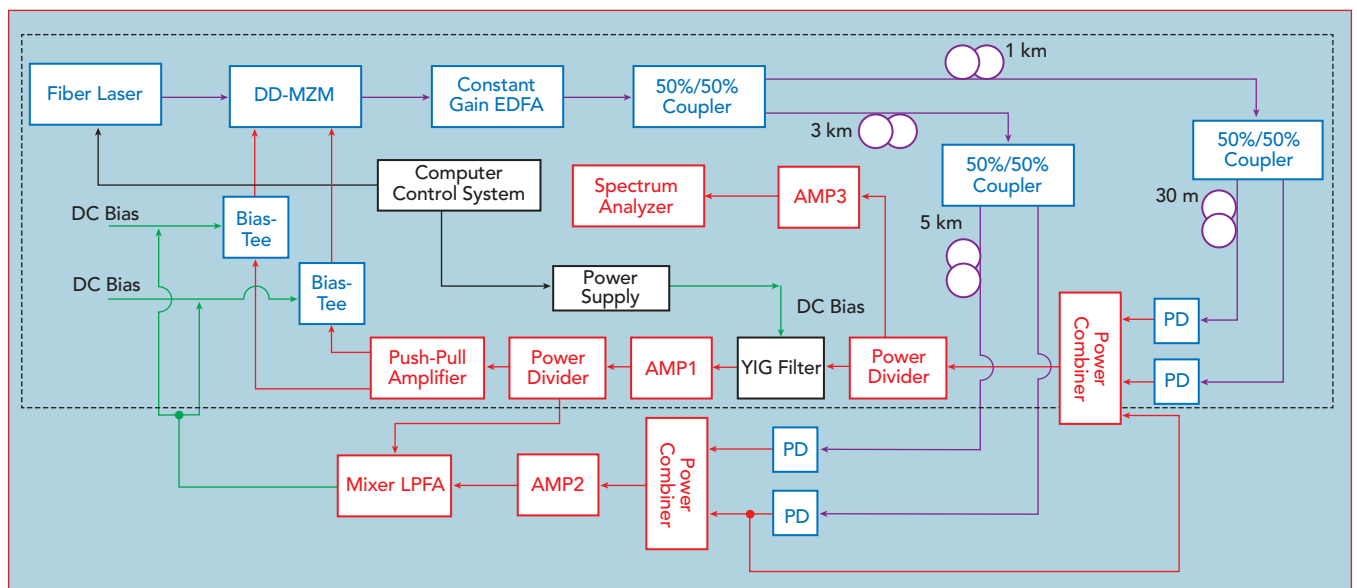

▲ Fig. 1 Detailed block diagram of the OEO system.

Technical Feature

pm of optical wavelength control at 1550 nm. Computer control generates both FMCW and frequency hopped operation of the synthesizer, enabling it to be used for remote sensing and secure communications applications. In Part 2 of the article, additional design innovations are described which lead to a compact OEO.⁵⁷⁻⁶⁰

SYNTHESIZER DESIGN

The block diagram of the OEO synthesizer is shown in **Figure 1**. A fiber laser with low relative intensity noise, the TWL-C-HP-M, is used to provide a tunable wavelength laser signal. The laser signal transmits through optical fiber delay lines and is received by high speed photodetectors (Discovery Semiconductors DSC50S) to generate an electrical signal which passes through a narrowband filter. This narrowband filter is the core of the OEO, used to select the oscillation frequency. A high Q metallic filter is the classic approach to realize a fixed frequency OEO, where mechanical adjustment of the cavity length tunes the frequency. As this approach is not suitable for computer control, a YIG filter³⁶ is used for this synthesizer design. The YIG filter is attractive because it has a broad tuning range and can be computer-controlled. To compensate for the poorer frequency selectivity of wide-tuning YIG filters, a narrowband optical transversal filter⁴² is added, realized with a 30 m fiber. The YIG filter provides coarse tuning of the synthesizer, i.e., 50 MHz/mA. The highest resolution for the power supply (Keysight E3631A) in constant current mode is 1 mA, so smaller frequency steps will be provided by the transversal filter.

An optical transversal filter⁴² can provide narrowband filtering of microwave signals; a first-order transversal filter is shown in **Figure 2**. An optical signal is divided into two paths, with one path the reference, the other creating the delay. This is represented by the following filter transfer function, in terms of RF frequency

$$H(\omega) = \frac{1 + \cos[\omega(\tau_d + \tau_D)]}{2} \quad (1)$$

where τ_d is the fiber delay at the fiber laser wavelength. The delay is related to the difference in length, ΔL , between the reference and delayed paths. $n(\lambda_0)$ is the index of refraction at the wavelength λ_0 .

$$\tau_d = \Delta L n(\lambda_0) / c \quad (2)$$

τ_D is a term reflecting fiber dispersion, expressed as

$$\tau_D = D \Delta L (\Delta \lambda) \quad (3)$$

In Equation 3, D is the dispersion parameter in units of ps/nm/km, while $\Delta \lambda$ is the difference between the optical source wavelength and original wavelength. The null-to-null bandwidth is around 4.5 MHz at 1550 nm. The tuning sensitivity achieved using the picometer resolution of the fiber laser is 20 kHz/pm. Using computer control, after setting the desired frequency, the frequency setting process terminates when the difference between the desired frequency and the detected frequency is smaller than half the fine tuning resolution, approximately 10 kHz; the final output is then shown on the LabVIEW display.

In addition to the optical frequency selectivity, SIL⁴⁹ SPILL⁵² and the combination SILPLL⁵³⁻⁵⁴ is used to reduce the synthesizer's phase noise, both close-in and far from the carrier frequency. The block diagram outside the dotted area of Figure 1 depicts the single delay loop SIL⁴⁹ and dual optical delayed DSPLL.⁵² There are two paths for the modulated signal after the MZM: one is used as the main loop of the OEO, with the other loop further split into two paths of 3 and 8 km, which are used as dual phase-locking signals. The combined phase-locking signal drives a PCB board containing the "Mixer LPFA" block shown in Figure 1. A double balanced mixer is integrated on the same board with a lowpass filter amplifier, realized with op-amp circuits, which serves as the phase detector and lowpass filter portion of the PLL. The phase error of the OEO main loop is com-

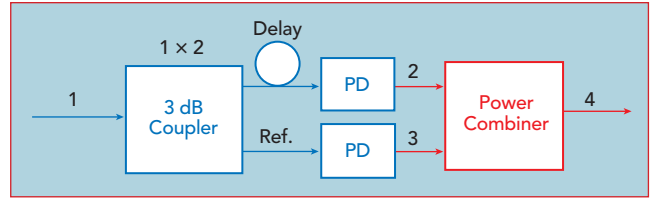

Fig. 2 First-order optical transversal filter using a 3 dB splitter and combiner with an optical delay in one path.

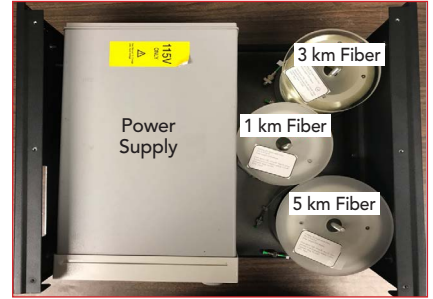

Fig. 3 View of the custom fiber mandrels adjacent to the computer-controlled DC power supply.

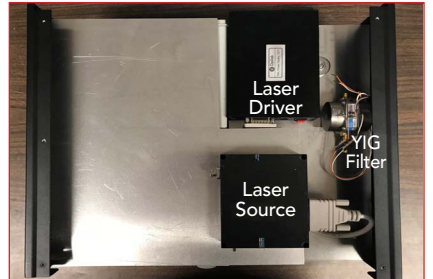
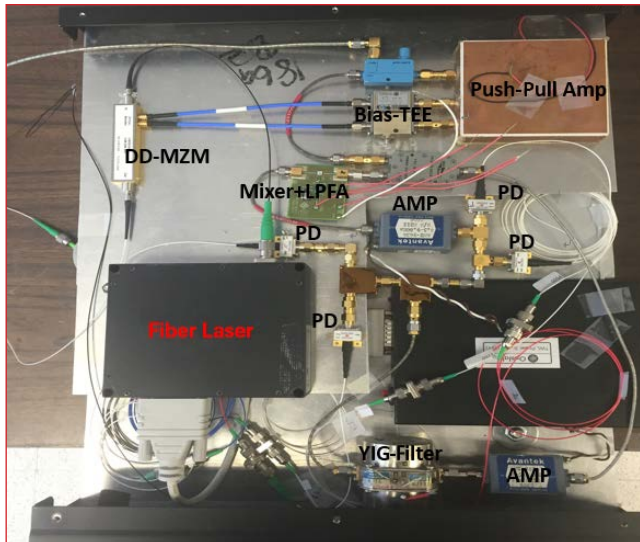

Fig. 4 View of the fiber laser source, driver and commercial YIG filter.

pared with the dual delay lines of the PLL, and the phase error signal is fed back to the bias port of the MZM. The self-injection locking signal takes advantage of the PLL path and shares the same fiber used in the SPILL path. The 3 km SIL signal is split from one PLL signal and directly injected into the output of the metallic cavity. The injected power level is given by $\rho = \sqrt{P_i/P_O}$, where P_i is the injected signal power and P_O the OEO power level. A higher value of ρ results in better suppression of the phase noise far away from the carrier.

After successfully demonstrating the synthesizer on a lab table, it was integrated into a 19 in. rack for practical use. The assembly detail is shown in the following views, where the step-by-step assembly of the system reflects the block diagram shown in Figure 1. The first floor of the synthesizer box (see **Figure 3**) comprises three fiber mandrels and the DC power supply. The top-side of the cover over the mandrels



▲ Fig. 5 View of the RF and fiber-optic components on the third level of the synthesizer housing.



▲ Fig. 6 Front view of the OEO synthesizer, showing the power supply (left), 1 and 5 km fiber mandrels, laser driver and other components.



▲ Fig. 7 Complete SILPLL OEO system.

and power supply integrates the remaining RF and fiber-optic components, mounted on a sheet metal cover and connected using coaxial cables or optical fibers (see **Figure 5**); this sheet is placed on top of the second level. **Figure 6** shows a front view of the three levels, with all the circuits packaged within the overall height of the enclosed box, covered with metal on the front, top and back sides, with venting to help dissipate the heat of the power supply. A commercial Er doped fiber amplifier (EDFA) is mounted on top of the OEO box and shares the screws with the OEO box for stabilization and to maintain good connection between the EDFA and OEO unit (see **Figure 7**).

The synthesizer has DB9 and RS232 interface ports for computer control of the laser source and DC power supply. The program for computer control, developed using LabVIEW 2018, controls the output wavelength of the fiber laser and the current bias of the YIG filter to realize the narrowband frequency selection (see **Figure 8**). To set the operating frequency, users type the desired

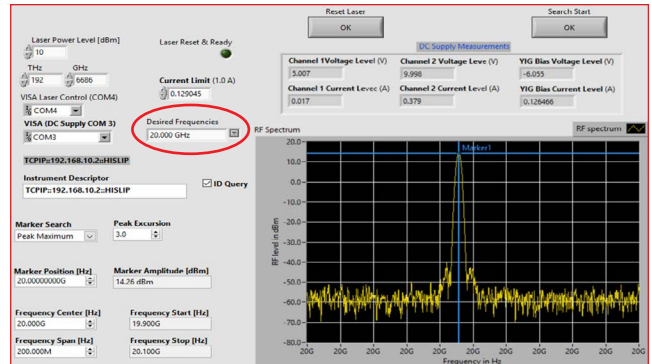

▲ Fig. 8 LabVIEW control interface for the synthesizer.

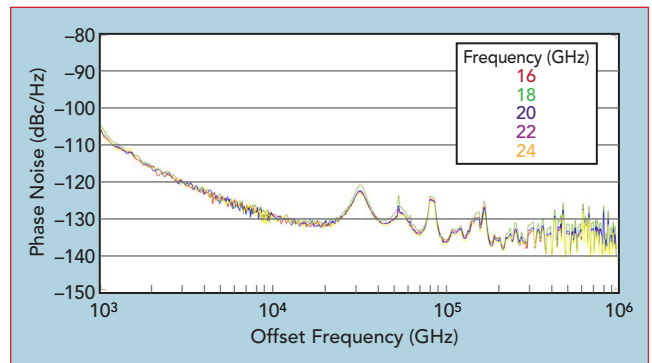

▲ Fig. 9 Measured phase noise of the K-Band OEO system with 16 to 24 GHz carriers.

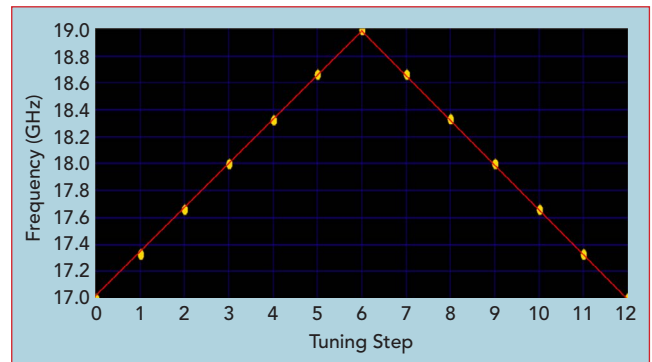

▲ Fig. 10 Linear frequency sweep using the LabView control program.

value into the graphical interface shown in the figure. Using a look-up table, the program iteratively changes the current bias of the YIG filter and wavelength of the fiber laser, corresponding to coarse and fine tuning, respectively. The desired frequency is achieved in under 15 seconds. The time for frequency acquisition reflects the iterative process to attain the proper YIG filter bias current and fiber laser wavelength, given the extremely narrowband bandpass characteristics of the cascaded YIG and optical transversal filters. This settling time can be reduced using a custom power supply and controllers.

The measured phase noise of the OEO system is shown in **Figure 9**. The synthesizer outputs are measured at steps of 2 GHz from 16 to 24 GHz, demonstrating operation across all of K-Band. The measured phase noise is -105 dBc/Hz at 1 kHz offset from the carrier and -130 dBc/Hz at 10 kHz offset. The long-term stability of the 19 in. unit was evaluated, recording a 4.5

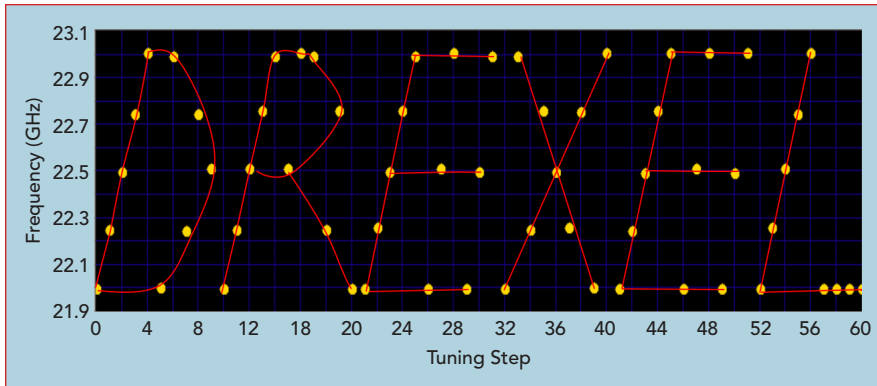

▲ **Fig. 11** Frequency sequence spelling DREXEL, demonstrating the broadband frequency hopping capability of the OEO synthesizer.

kHz frequency shift over 1 hour. The estimated rms timing jitter of the synthesizer is under 10 fs, which can be reduced using SILTPLL.⁵⁴⁻⁵⁵ A contributor to the phase noise is the $1/f$ noise of the amplifier; this can be improved using a SiGe HBT amplifier rather than GaAs PHEMT,⁶¹⁻⁶² and with proper selection of the operating conditions of the transistors.⁶³

Computer control of the K-Band synthesizer was demonstrated by generating a sequence of frequencies for several applications. **Figure 10** shows the LabVIEW routine for linear frequency modulation, representing a practical FMCW radar application. The program steps the frequency from 17 to 19 GHz with six linear steps, then steps back at the same rate to 17 GHz. **Figure 11** shows a pseudo-random frequency hopped pattern representing a frequency hopped communication system; the pattern was designed to spell DREXEL after 61 steps. These examples demonstrate the frequency synthesizer's tuning capability, low close-in phase noise and computer-controlled frequency selection.

CONCLUSION

This article discussed the realization of a LabVIEW-based, computer-controlled K-Band synthesizer using an MZM OEO system. Suppression of the inter-modal oscillation of long fiber-optic delay lines reduces the close-in phase noise.⁵⁵ The measured phase noise is around -130 dBc/Hz at 10 kHz offset over all of K-Band, from 16 to 24 GHz. The design of a reduced cost and smaller OEO synthesizer using a PhC-PM

device, Sagnac loop PM-IM converter⁶⁴⁻⁶⁵ and a multi-mode, multi-section semiconductor laser⁵⁸ will be presented in Part 2 of this article.⁶⁶ ■

References

1. R. Adler, "A Study of Locking Phenomena In Oscillators," *Proceedings of the IRE* 34, No. 6, 1946, pp. 351-357.
2. L. J. Paciorek, "Injection Locking of Oscillators," *Proceedings of the IEEE* 53, No. 11, 1965, pp. 1723-1727.
3. A. Blanchard, "Phase Locked Loops: Application to Coherent Receiver Design," Wiley, New York, 1976.
4. U. L. Rohde, "Digital PLL Frequency Synthesizers: Theory and Design," Prentice Hall, New York, 1983.
5. U. L. Rohde, "Microwave and Wireless Synthesizers: Theory and Design," Wiley, New York, 1997.
6. A. S. Daryoush and P. R. Herczfeld, "Indirect Optical Injection-Locking of Multiple X-Band Oscillators," *Electronics Lett.*, Vol. 22, No. 3, 1986, pp. 133-134.
7. A. S. Daryoush, "Optical Synchronization of Millimeter-Wave Oscillators for Distributed Millimeter-wave Systems," *IEEE Trans. on Microwave Theory and Techniques*, Vol. 38, No. 5, May 1990, pp. 1371-1373.
8. A. S. Daryoush, P. R. Herczfeld, P. Wahi and Z. Turski, "Comparison of Indirect Optical Injection Locking Techniques of Multiple X-Band Oscillators," *IEEE Trans. on Microwave Theory and Techniques*, Vol. 34, No. 12, December 1986, pp. 1363-1370.
9. P. R. Herczfeld, A. S. Daryoush, A. Rosen, A. K. Sharma and V. M. Contarino, "Indirect Subharmonic Optical Injection Locking of a Millimeter Wave IMPATT Oscillator," *IEEE Trans. on Microwave Theory and Techniques*, Vol. 34, No. 12, December 1986, pp. 1371-1376.
10. A. Daryoush, P. Herczfeld, V. Contarino, A. Rosen, Z. Turski and P. Wahi, "Optical Beam Control of Millimeter Wave Phased Array Antennas For Communications," *16th European Microwave Conference*, 1986, pp. 864-869.
11. E. C. Niehenke and P. Herczfeld, "An

Optical Link for W-Band Transmit/Receive Applications," *1997 IEEE International Microwave Symposium Digest*, Vol. 1, pp. 35-38.

12. S. Lipsky and A. S. Daryoush, "Fiber Optic Methods for Injection-Locked Oscillators," *Microwave Journal*, Vol. 35, No. 1, January 1992, pp. 80-88.
13. X. Zhou, A. S. Daryoush, "An Injection Locked Push-Pull Oscillator at Ku-Band," *IEEE Microwave & Guided Wave Lett.*, Vol. 3, No. 8, 1993, pp. 244-246.
14. A. S. Daryoush, K. Kamogawa, T. Tokumitsu and H. Ogawa, "Phase Noise Characteristics of MMIC Based ILO for Ka-Band Applications," *The Journal of Franklin Institute, Special Issue on Benjamin Franklin Symposium*, Vol. 338, No. 1, January 1999, pp. 33-42.
15. P. R. Herczfeld, A. Paoletta, A. S. Daryoush, W. Jemison and A. Rosen, "Optical Control of MMIC-Based T/R Modules," *Microwave Journal*, Vol. 31, No. 5, May 1988, pp. 309-322.
16. X. Zhang and A. S. Daryoush, "Full 360° Phase Shifting of Injection Locked Oscillators," *IEEE Microwave and Guided Wave Letters*, Vol. 3, No. 1, 1993, pp. 14-16.
17. X. Zhou, X. Zhang and A. S. Daryoush, "A New Approach for a Phase Controlled Self-Oscillating Mixer," *IEEE Trans. Microwave Theory and Tech.*, Vol. 45, No. 2, February 1997, pp. 19-204.
18. A. Daryoush, P. Herczfeld, V. Contarino, A. Rosen and Z. Turski, "Optical Beam Control of mm-Wave Phased Array Antennas for Communications," *Microwave Journal*, Vol. 30, 1986, p. 97.
19. X. Zhang, X. Zhou, B. Aliener and A. S. Daryoush, "A Study of Subharmonic Injection Locking Local Oscillators," *IEEE Microwave & Guided Wave Lett.*, Vol. 2, No. 3, 1992, pp. 97-99.
20. X. Zhang, X. Zhou and A. S. Daryoush, "A Theoretical and Experimental Study of the Noise Behavior of Subharmonically Injection Locked Local Oscillators," *IEEE Trans. Microwave Theory & Tech.*, Vol. 40, No. 5, 1992, pp. 895-902.
21. H. P. Moyer and A. S. Daryoush, "A Unified Analytical Model and Experimental Validations of Injection-Locking Processes," *IEEE Trans. on Microwave Theory & Tech*, Vol. 48, No. 4, 2000, pp. 493-499.
22. B. Razavi, "A Study of Injection Locking and Pulling in Oscillators," *IEEE J. Solid-State Circuits*, Vol. 39, No. 9, September 2004, pp. 1415-1424.
23. A. Mirzaei, M. E. Heidari and A. A. Abidi, "Analysis of Oscillators Locked by Large Injection Signals: Generalized Adler's Equation and Geometrical Interpretation," *IEEE Custom Integrated Circuits Conference 2006*, pp. 737-740.
24. A. S. Daryoush, D. Sturzebecher and X. Zhang, "Sub-Harmonically Injection Locked Oscillators," *U.S. Patent 5302918*, April 12, 1994.
25. D. J. Sturzebecher, X. Zhou, X. Zhang and A. S. Daryoush, "Optically Controlled Oscillators for Millimeter-Wave Phased Array Antennas," *IEEE Trans.*

- Microwave Theory and Techniques*, Vol. 41, No. 6/7, 1993, pp. 998–1004.
26. X. Zhou and A. S. Daryoush, "An Efficient Self-Oscillating Mixer for Communications," *IEEE Trans. on Microwave Theory & Tech.*, Vol. 42, No. 10, 1994, pp. 1858–1862.
 27. M. R. Tofighi and A. S. Daryoush, "A 2.5 GHz InGaP/GaAs Differential Cross-Coupled Self-Oscillating Mixer (SOM) IC," *IEEE Microwave & Wireless Components Lett.*, Vol. 15, No. 4, 2005, pp. 211–213.
 28. A. K. Poddar and U. L. Rohde, "Metamaterial Resonator Based Device," *U.S. Patent 9608564B2*, March 28, 2017.
 29. R. T. Logan, "Widely Tunable Oscillator Stabilization Using Analog Fiber Optic Delay Line," *U.S. Patent 5204640*, April 20, 1993.
 30. X. S. Yao and L. Maleki, "Optoelectronic Microwave Oscillator," *J. Opt. Soc. Am.*, B 13, 1996, pp. 1725–1735.
 31. A. S. Daryoush, A. K. Poddar, T. Sun and U. L. Rohde, "Optoelectronic Oscillators: Recent and Emerging Trends," *Microwave Journal*, October 2018, pp. 58–76.
 32. S. Fedderwitz, A. Stohr, S. Babieli, V. Rymanov and D. Jager, "Opto-Electronic Dual-Loop 50 GHz Oscillator With Wide Tunability and Low Phase Noise," *Proc. of 2010 IEEE Microwave Photonics*, pp. 224–226.
 33. M. Kaba et al., "Improving Thermal Stability of Opto-Electronic Oscillators," *IEEE Microwave Magazine*, Vol. 7, No. 4, August 2006, pp. 38–47.
 34. A. S. Daryoush, H. W. Li, M. Kaba, G. Bouwmans, D. Decoster, J. Chazelas and F. Deborgies, "Passively Temperature Stable Opto-electronic Oscillators Employing Photonic Crystal Fibers?," *Proc. of the European Microwave Association*, Vol. 3, No. 3, September 2007, pp. 201–209.
 35. L. Zhang, V. Madhavan, R. Patel, A. K. Poddar, U. L. Rohde and A. S. Daryoush, "Ultra Low FM Noise In Passively Temperature Compensated Microwave Opto-Electronic Oscillators," *Proc. IEEE International Microwave and RF Conference*, December 2013.
 36. M. Aigle et al., "A Systematic Way to YIG-Filter-Design," *37th European Microwave Conference*, 2007.
 37. D. Elyahu and L. Maleki, "Tunable, Ultra-Low Phase Noise YIG-Based Opto-Electronic Oscillator," *2003 IEEE MTT-S International Microwave Symposium Digest*, Vol. 3, pp. 2185–2187.
 38. J. C. Papp and Y. Y. Koyano, "An 8-18 GHz YIG-Tuned FET Oscillator," *IEEE Trans. on Microwave Theory and Techniques*, Vol. 28, July 1980, pp. 762–767.
 39. Y. Jiang et al., "A Selectable Multiband Bandpass Microwave Photonic Filter," *IEEE Photonics Journal*, Vol. 5, No. 3, June 2013, p. 3.
 40. Mora et al., "Photonic Microwave Tunable Single-Bandpass Filter Based on a Mach-Zehnder Interferometer," *J. Lightwave Tech.*, Vol. 24, No. 7, July 2006.
 41. Y. Jiang et al., "A Selectable Multiband Bandpass Microwave Photonic Filter," *IEEE Photonics Journal*, Vol. 5, No. 3, June 2013, pp. 5500509–5500509.
 42. J. W. Fisher et al., "Phase Noise Performance Of Optoelectronic Oscillator Using Optical Transversal Filters," *2014 IEEE Benjamin Franklin Symposium on Microwave and Antenna Sub-systems for Radar, Telecommunications and Biomedical Applications*, pp. 1–3.
 43. Lute Maleki et al., "Tunable Opto-Electronic Oscillator Having Optical Resonator Filter Operating at Selected Modulation Sideband," *U.S. Patent 8976822B2*, March 10, 2015.
 44. T. Sun, Li. Zhang, A. K. Poddar, U. L. Rohde and A. S. Daryoush, "Frequency Synthesis of Forced Opto-Electronic Oscillators at the X-Band," *Chin. Opt. Lett.*, Vol. 15, No. 1, January 10, 2017, p. 010009.
 45. A. S. Daryoush, "Phase Noise Degradation in Nonlinear Fiber Optic Links Distribution Networks for Communication Satellites," *Microwave Photonics from Components to Applications and Systems*, Kluwer Academic Publishers, May 2003.
 46. H. C. Chang, A. Borgioli, P. Yeh and R. A. York, "Analysis of Oscillators with External Feedback Loop for Improved Locking Range and Noise Reduction," *IEEE Trans. Microwave Theory Tech.*, Vol. 47, No. 8, August 1999, pp. 1535–1543.
 47. H. C. Chang, "Phase Noise in Self-Injection Locked Oscillators-Theory and Experiment," *IEEE Trans. Microw. Theory Tech.*, Vol. 51, No. 9, September 2003, pp. 1994–1999.
 48. T. P. Wang, Z. M. Tsai, K. J. Sun and H. Wang, "Phase Noise Reduction of X-Band Push-Push Oscillator with Second Harmonic Self-Injection Techniques," *IEEE Trans. Microw. Theory Tech.*, Vol. 55, No. 1, January 2007, pp. 66–77.
 49. L. Zhang et al., "Analytical and Experimental Evaluation of SSB Phase Noise Reduction in Self-Injection Locked Oscillators Using Optical Delay Loops," *IEEE Photonics J.*, Vol. 5, No. 6, December 2013.
 50. M. Alemohammad, L. Yifei and P. Herzfeld, "Design and Dynamics of Multi-loop Optical Frequency Locked Loop," *J. Lightwave Technology*, Vol. 31, No. 22, November 2013, pp. 3453–3459.
 51. G. Pillet et al., "Dual-Frequency Laser at 1.5 μm for Optical Distribution and Generation of High-Purity Microwave Signals," *Journal of Lightwave Technology*, Vol. 26, No. 15, August 2008.
 52. L. Zhang, A. K. Poddar, U. L. Rohde and A. S. Daryoush, "Comparison of Optical Self-Phase Locked Loop Techniques for Frequency Stabilization of Oscillators," *IEEE Photonics Journal*, Vol. 6, No. 5, October 2014, pp. 1–15.
 53. A. K. Poddar, U. L. Rohde and A. S. Daryoush, "Self-Injection Locked Phase Locked Loop Optoelectronic Oscillator," *U.S. Patent 20140186045*, July 3, 2014.
 54. L. Zhang et al., "Self-ILPLL Using Optical Feedback for Phase Noise Reduction in Microwave Oscillators," *IEEE Photonics Technology Letters*, Vol. 27, No. 6, 2015, pp. 624–627.
 55. T. Sun et al., "Limits in Timing Jitters of Forced Microwave Oscillator Using Optical Self-ILPLL," *IEEE Photonics Technology Letters*, Vol. 29, No. 2, January 15, 2017, pp. 181–184.
 56. T. Sun, L. Zhang, K. Receveur, A. K. Poddar, U. L. Rohde and A. S. Daryoush, "Oscillator Phase Noise Reduction using Optical Feedback with Dual Drive Mach-Zehnder Modulator," *Proc. of 2015 IEEE International Microwave Symp.*, May 2015.
 57. A. K. Poddar, U. L. Rohde and A. S. Daryoush, "Integrated Production of Self-Injection Locked Self-Phase Loop Locked Opto-Electronic Oscillators," *U.S. Patent 20140270786*, September 18, 2014.
 58. T. Sun and A. S. Daryoush, "Ultra-Stable RF Signal Generator Using Beat-Notes Output of DBR Based Multi-Modes Lasers," *2017 International Topical Meeting on Microwave Photonics*, 2017, pp. 1–3.
 59. A. S. Daryoush and T. Sun, "Compact Highly Stable Synthesized RF Sources Using Self Mode-Locked Beat-Notes of Multimodes of Multimode Lasers," *U.S. Patent Application No. 62/576,398*, October 24, 2017.
 60. A. K. Poddar, U. L. Rohde and A. S. Daryoush, "Optoelectronic Oscillator using Monolithically Integrated Multi-Quantum Well Laser and Phase Modulator," *U.S. Patent Application No. 63/702,970* July 25, 2018.
 61. X. Zhang and A. S. Daryoush, "Bias Dependent Low Frequency Noise Up-Conversion in HBT Oscillators," *IEEE Microwave & Guided Wave Lett.*, Vol. 4, No. 12, December 1994.
 62. R. Boudot and E. Rubiola, "Phase Noise in RF and Microwave Amplifiers," *IEEE Trans. Ultrasonics, Ferroelectrics and Freq. Control*, Vol. 59, No. 12, December 2012, pp. 2613–2624.
 63. X. Zhang, D. Sturzebecher and A. S. Daryoush, "Comparison of the Phase Noise Performance of HEMT and HBT Based Oscillators," *IEEE 1995 International Microwave Symposium Digest*, pp. 697–700.
 64. F. Pantano et al., "Forced Opto-Electronic Oscillators Using Efficient PBG Based Phase Modulators," *2018 IEEE International Frequency Control Symposium*, pp. 1–3.
 65. F. T. Pantano, K. Wei, T. Sun and A. S. Daryoush, "SILPLL Based Forced Opto-Electronic Oscillator using a Phase Modulator in a Sagnac Loop," *2018 IEEE Topical Conference on Wireless Sensors and Sensor Networks*, pp. 66–69.
 66. A. S. Daryoush, T. Sun, K. Wei, F. Pantano, A. K. Poddar and U. L. Rohde, "Computer Control of Self Injection Locked Phase Locked Opto-Electronic Oscillator Based K-Band Frequency Synthesizers: Part 2," *Microwave Journal*, Vol. 62, No. 9, September 2019.